

REVISIONS	
ISS	DESCRIPTION \ DATE

RoHS COMPLIANT

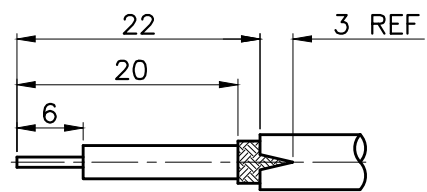

RECOMMENDED
CABLE STRIPPING DIM'S

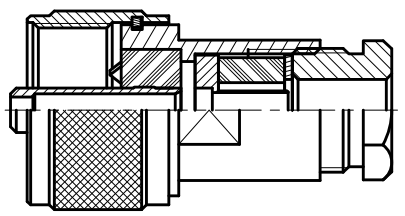
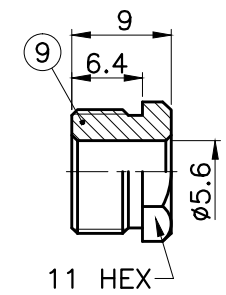
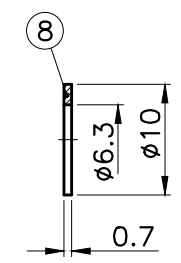
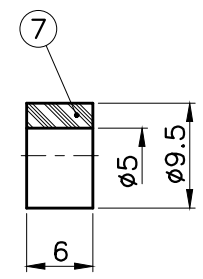
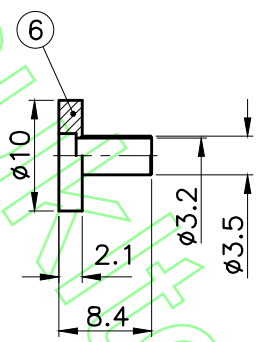
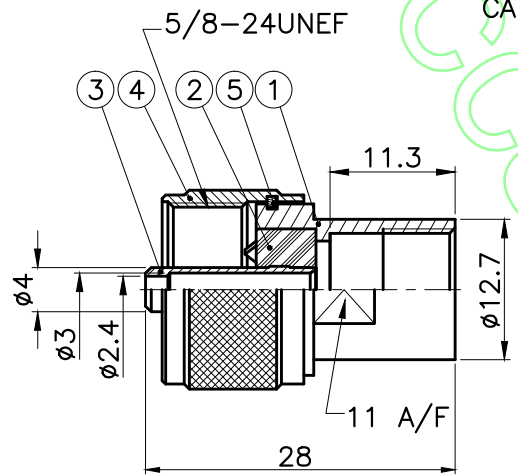

CONNECTORS CABLES
CCS
SPECIALISTS LTD.

TITLE: UHF MALE CLAMP
FOR RG223, RG400

APRD:	UNLESS OTHERWISE SPECIFIED TOLERANCES 0.5-6 = ±0.2 >6-30 = ±0.4 >30-120 = ±0.6 >120-315 = ±1 >315-1000 = ±1.6 ANGLES = ±5°
CHKD:	
DR:	

PART NO: UPSC223 030
DR. NO:)

DATE: 12/25/12" UNIT: mm
SHEET: . SCALE: 1.5/1

NO.	DESCRIPTION	MATERIAL	FINISH
9	NUT	BRASS	NICKEL
8	WASHER	BRASS	NICKEL
7	GASKET	SILICONE	WHITE
6	TOP HAT	BRASS	NICKEL
5	RING	BRASS	NONE
4	SHELL	BRASS	NICKEL
3	CONTACT PIN	BRASS	GOLD
2	INSULATOR	TEFLON	WHITE
1	BODY	BRASS	NICKEL