

ISS	REVISIONS	DESCRIPTION \ DATE
1		

RoHS COMPLIANT

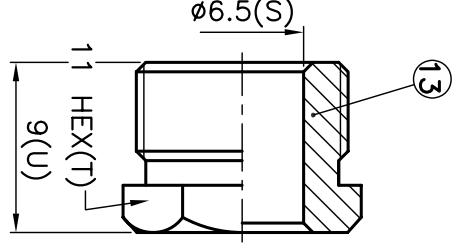
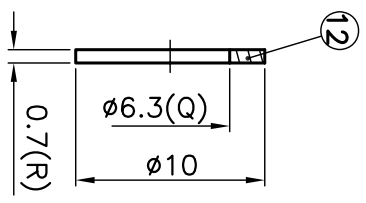
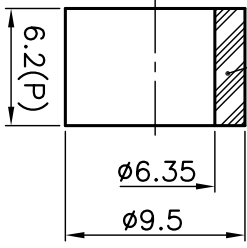
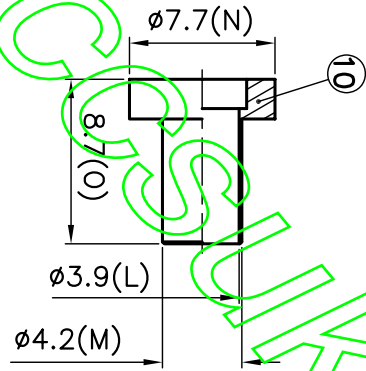
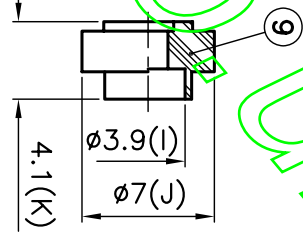
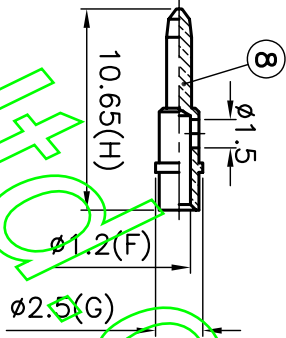
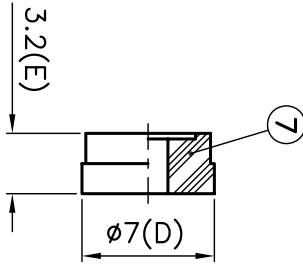
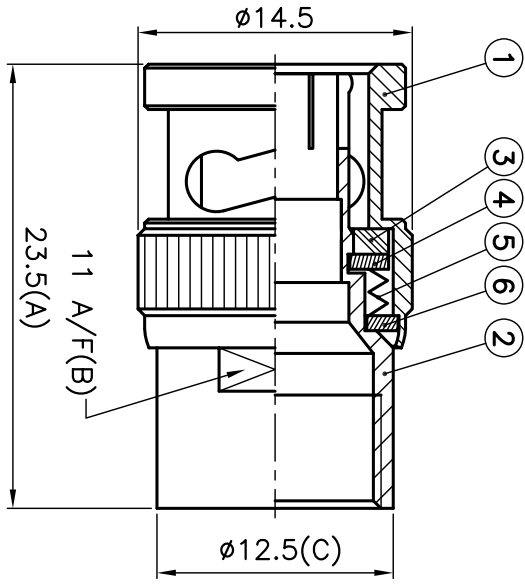

CONNECTORS CABLES
CHS
SPECIALISTS-LTD.

TITLE: BNC MALE CLAMP
(75 ohm)(FOR RG59/U)

PART NO: BPSC59

DR. NO:

APRD:	UNLESS OTHERWISE SPECIFIED TOLERANCES 0.5-6 = ±0.2 >6-30 = ±0.4 >30-120 = ±0.6 >120-315 = ±1.0 >315-1000 = ±1.6 ANGLES = 15°
CHKD:	
DR:	
DATE: 03/22/12"	UNIT: mm
SHEET: .	SCALE: 2.5/1

NO.	DESCRIPTION	MATERIAL	FINISH
13	NUT	BRASS	NICKEL
12	WASHER	BRASS	NICKEL
11	GASKET	SILICONE	WHITE
10	TOP HAT	BRASS	NICKEL
9	INSULATOR	TEFLON	WHITE
8	CONTACT PIN	BRASS	GOLD
7	INSULATOR	TEFLON	WHITE
6	WASHER	STEEL	NICKEL
5	SPRING	STEEL	NICKEL
4	C WASHER	STEEL	NICKEL
3	GASKET	SILICONE	RED
2	BODY	BRASS	NICKEL
1	SHELL	ZINC ALLOY	NICKEL
		MATERIAL	FINISH